

# The Emerging WDM EPON

*Mirjana Radivojević*

Faculty of Computing Science, University Union, Belgrade,  
Serbia

*Petar Matavulj*

Faculty of Electrical Engineering, University of Belgrade,  
Belgrade, Serbia

# Book content

- Preface
- 1. Introduction
- 2. Quality of service implementation
- 3. PON evolution
- 4. Single-channel EPON
- 5. Multichannel EPON
- 6. WDM EPON architecture
- 7. Performance evaluation
- Conclusion

# Broadband : facts

- High-speed Internet expands our ability to communicate, learn and entertain.
- Internet access is commonly associated with entertainment and information browsing.
- Most end-users use Internet connection for exchanging information, online gaming and applications like Facebook and Twitter.
- On the other side, the number of business users has dramatically increased as network infrastructure is becoming the necessity for successful business operations.

# Broadband : facts & perspective

- Service providers are mainly focused on the development and implementation of applications like video on demand (VoD), high definition TV (HDTV), and online gaming which further increases the need for higher access speeds

**but**

broadband infrastructure is able to improve the quality of life in addition to supporting and improving business operations:

**broadband online learning, video conferencing, online education for people with disabilities, national health network and electronic health records are only a few examples that demonstrate the importance of the further development of broadband infrastructure.**

# Broadband user

- The 'new broadband' user requests from a service provider a much wider range of services than it has until recently been the case.

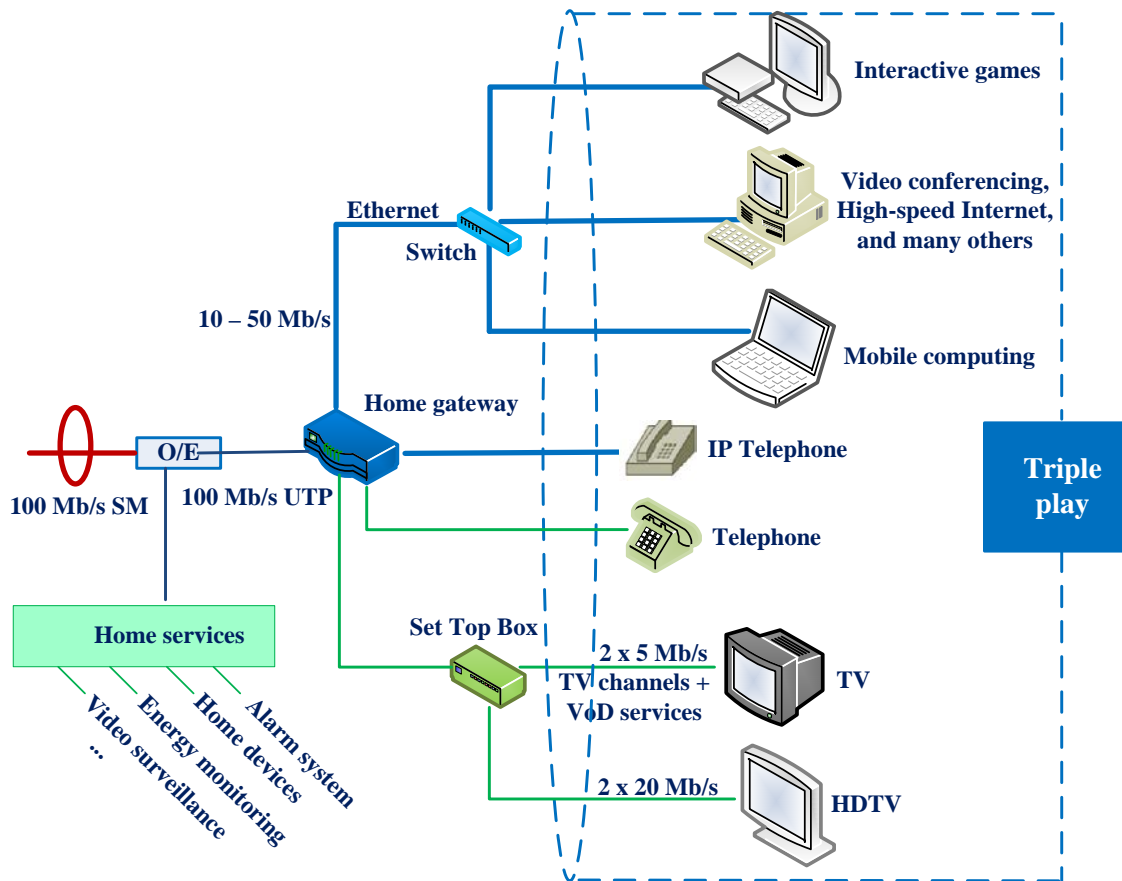

In addition to basic data transfer, service providers in the access network must now provide the bandwidth that will be able to support the transmission of different applications such as VoD, HDTV and many others; while at the same time it must be able to provide the appropriate service quality to end-users.

# Broadband access network

- Data transmission and networking technologies have witnessed tremendous growth over the past decade but much of the development and growth has been primarily in the core networks where high capacity routers and ultra-high-capacity optical links have created a truly broadband infrastructure.
- **The so-called first mile – the access network connecting end-users to backhaul infrastructure – remains a bottleneck in terms of the bandwidth and quality of service it affords to the end-users.**

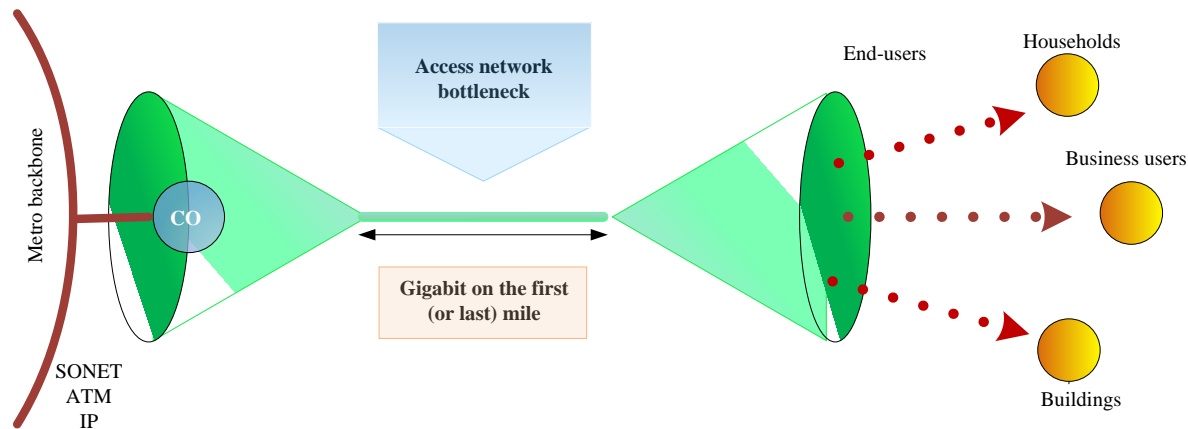

# Broadband access network

- Today, the term 'residential broadband' describes the group of technologies that provide high-bandwidth connection to the Internet for residential consumers.

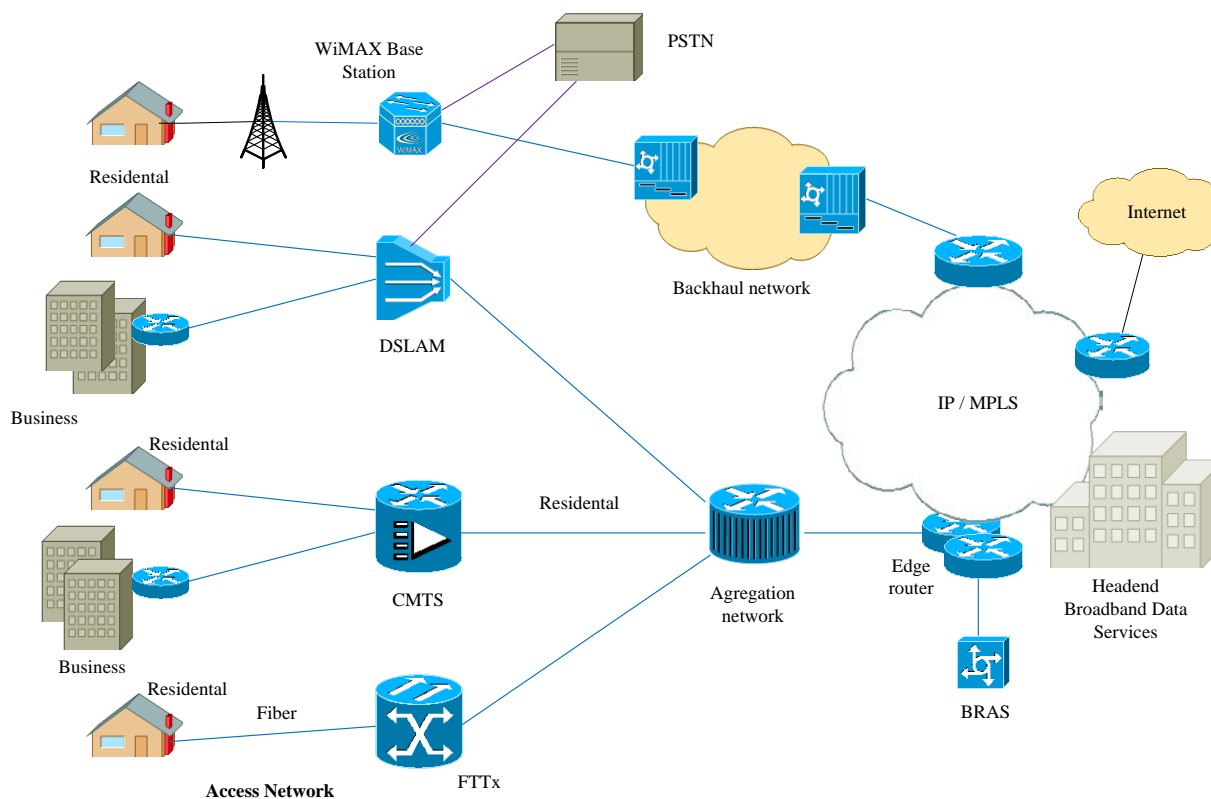

*Broadband*  
technologies:

- DSL – distance limitation,
- HFC – shared medium,
- *Radio* – bandwidth limitation,
- PON – APON, EPON, GPON : NGNs candidates.

# Broadband access network

Development of  
broadband services

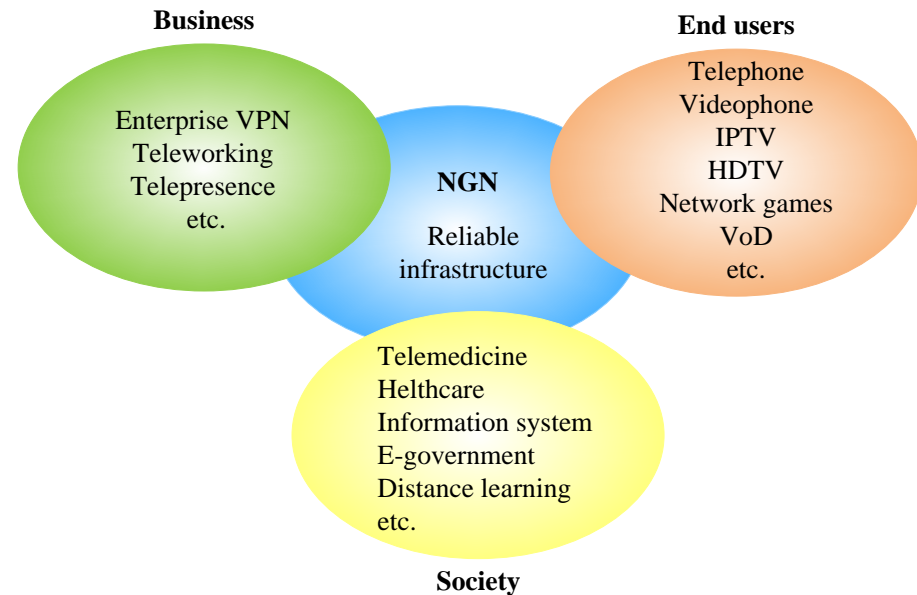

- QoS support in the access networks is becoming a key concern for realization of multiservice networks.



# QoS (Quality of Service) support

---

The Emerging WDM EPON

# Definition

- Within a converged network, QoS is by far the most important implementation consideration.
- QoS is a networking term that specifies a guaranteed network data performance level.
- QoS could also be defined as a set of algorithms and forms which enable different priority to be given to different applications, users, or data flows, or to guarantee a certain level of performance for data flow.

# QoS parameters

The performance of a packet based network can be characterized by several parameters :

- Bandwidth,
- The average packet delay (latency),
- The delay variation (jitter),
- The percentage of lost packets (packet-loss ratio).

# QoS models

- The IETF (Internet Engineering Task Force) standardized two QoS architectures :
  - **Integrated services architecture (IntServ)**, which provides end-to-end QoS on a per-flow basis and incorporates end-to-end signaling;
  - **Differentiated services architecture (DiffServ)**, which supports QoS for traffic aggregates through the implementation of different QoS for different traffic classes.

# IntServ model

- In this model, every router in the system implements IntServ, and every application that requires some kind of guarantees has to make an individual reservation using the transport layer RSVP (Resource Reservation Protocol) to request and reserve resources through a network.

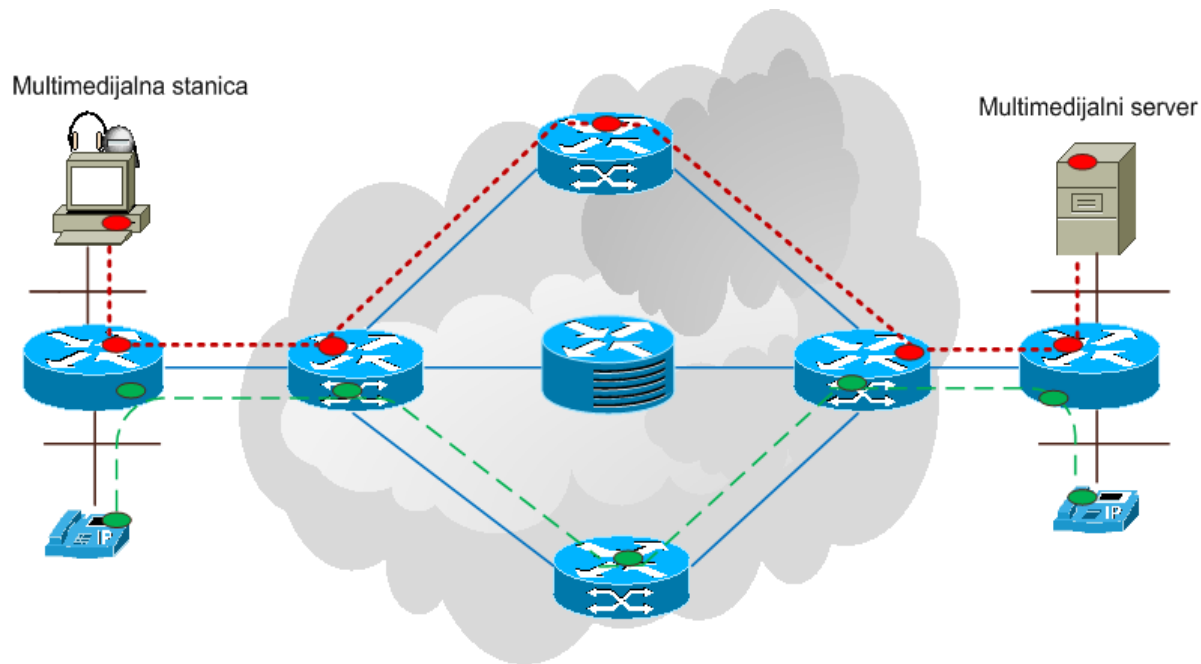

Advantage- IntServ provides service classes which closely match different application types. Disadvantage - end-to-end service guarantees cannot be supported unless all nodes along the route support IntServ hence scalability is a key architectural concern.

# DiffServ model

- Differentiated services or DiffServ is a computer networking architecture that specifies a simple, scalable and coarse-grained mechanism for classifying, managing network traffic and providing QoS guarantees on modern IP networks.
- DiffServ operates on the principle of traffic classification, where each data packet is placed into a limited number of traffic classes, rather than differentiating network traffic based on the requirements of an individual flow.

# DiffServ model

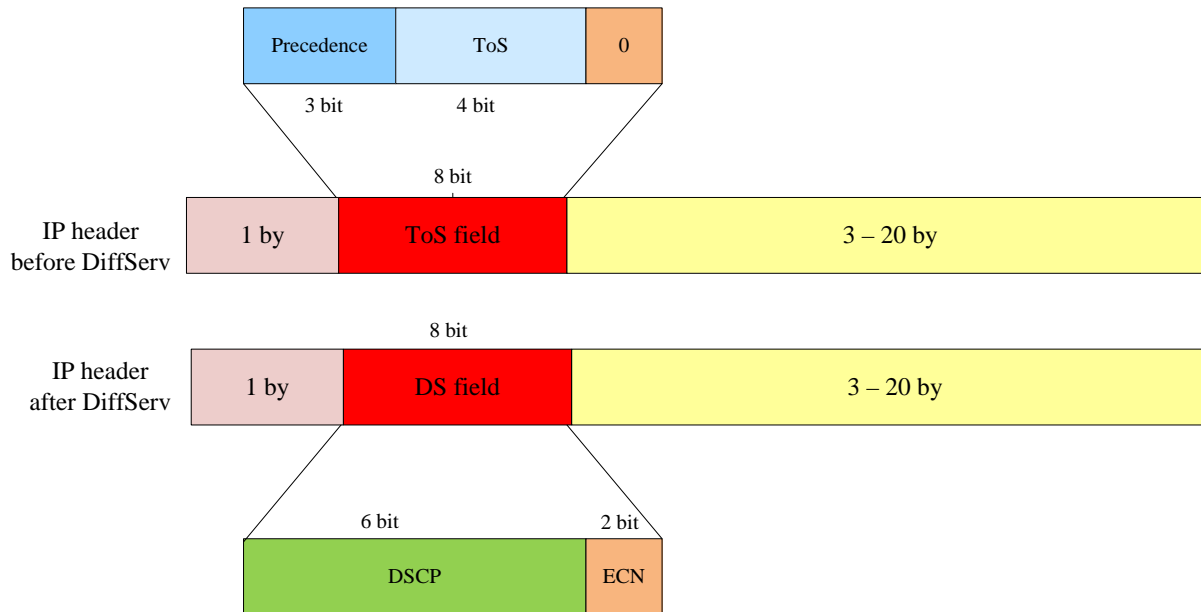

ToS byte	P2	P1	P0	T3	T2	T1	T0	ZERO
DS byte	DS5	DS4	DS3	DS2	DS1	DS0	ECN1	ECN0
	Class selector (CS)			Drop probability (DP)				

- DiffServ-aware routers implement per-hop behaviors (PHBs), which define the packet forwarding properties associated with a certain class of traffic.
- Traffic may be classified by many different parameters, such as source address, destination address or traffic type and assigned to a specific traffic class.
- According to the standard (RFC 2474), the PHB is determined by the differentiated services (DS) field of the IPv4 header.

# DiffServ model

## DSCP encoding

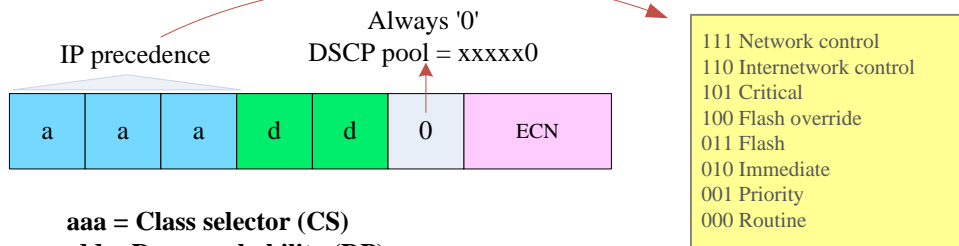

aaa = Class selector (CS)  
dd = Drop probability (DP)

a)

**Default PHB** = 000000

b)

**Expedite forwarding PHB** = 101110

aaa=101 (IP precedence =5)

dd = 11 (No drop probability)

c)

Class	CS	DP	
AF1	001	dd	0
AF2	010	dd	0
AF3	011	dd	0
AF4	100	dd	0

Drop probability (dd)	Value
Low	01
Medium	10
High	11

d)

**Class selector PHB** = 'xxx000'

- Default PHB - which is typically best-effort (BE) traffic;
- Expedited forwarding (EF) PHB - dedicated to low-loss, low-latency traffic;
- Assured forwarding (AF) PHB - gives assurance of delivery under prescribed conditions;
- Class selector PHBs - which maintain backward compatibility with the IP Precedence field.



# QoS mechanisms

- QoS mechanisms represent a set of techniques or tools which allow traffic classification in an IP network based on models of differentiated services and enable a given family of basic parameters of QoS (bandwidth, delay, delay variation, and packet loss percentage) to be maintained in pre-defined boundaries on a source to destination packets' route.
- QoS mechanisms can be divided into three main categories:
  - Classification;
  - Scheduling;
  - Network provisioning.

# PON (Passive Optical Networks)

---

The Emerging WDM EPON

# PON

- Fiber optical access networks of today are getting increasingly more attention as they offer the ultimate solution for delivering different services to end-users.
- Due to the lack of active units in the light path, the architecture of PON is simple, cost-effective and offers bandwidth which is highly unlikely to be achieved by other access methods.

# PON

- The downstream and upstream signals are carried over the same fiber.
- In the downstream direction (from the OLT to ONUs), a PON is a point-to-multipoint network. The OLT typically has the entire downstream bandwidth available to it at all times.
- In the upstream direction, a PON is a multipoint-to-point network where multiple ONUs transmit toward the OLT.

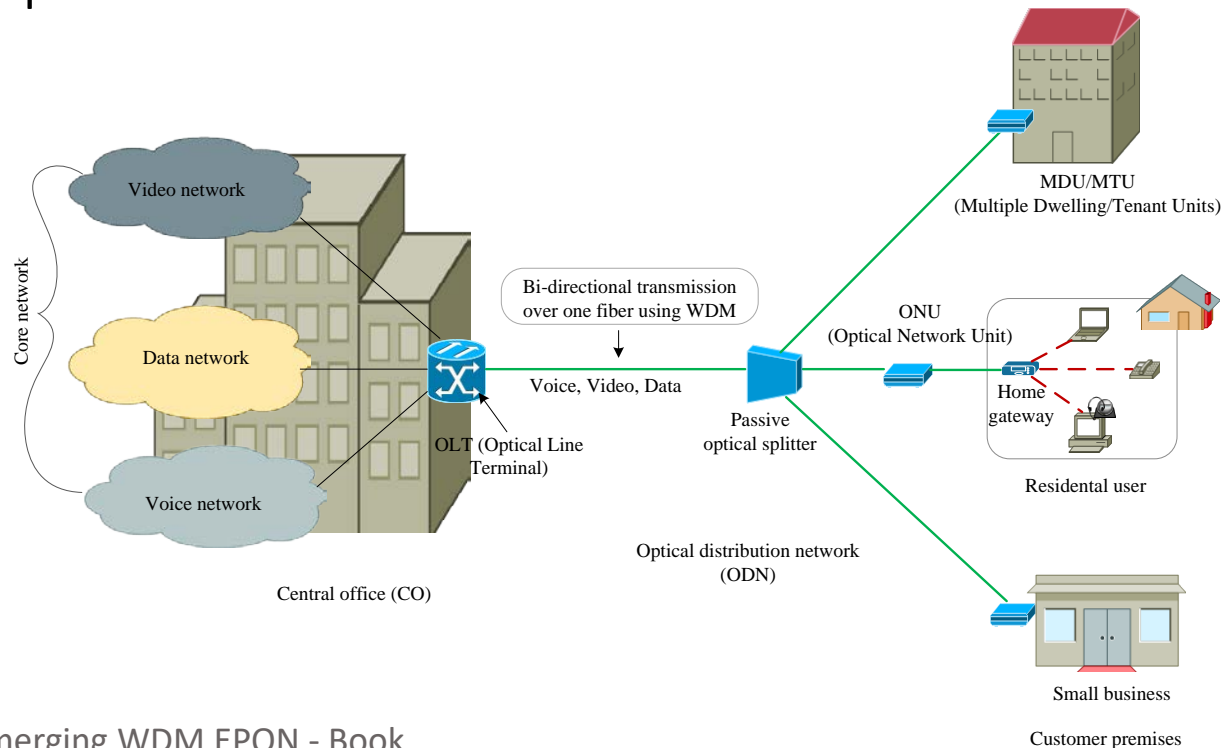

# TDM (Time Division Multiplexing) PON

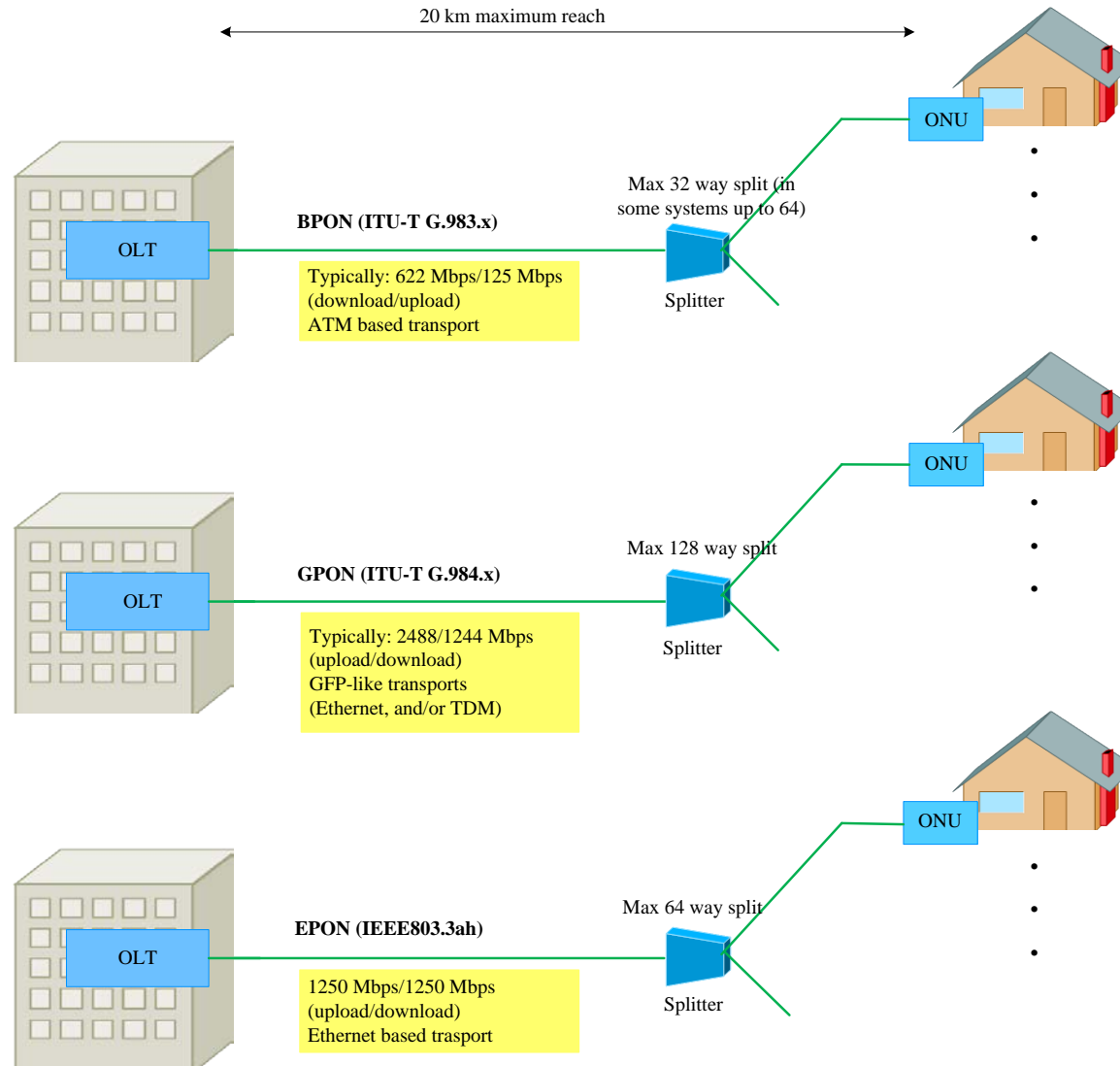

# WDM (Wavelength Division Multiplexing) PON

- WDM PONs (Wavelength Division Multiplexing Passive Optical Networks) are the next generation in the development of access networks since they can offer the highest bandwidth and the successful transmission of multimedia real-time applications in terms of QoS and SLAs.

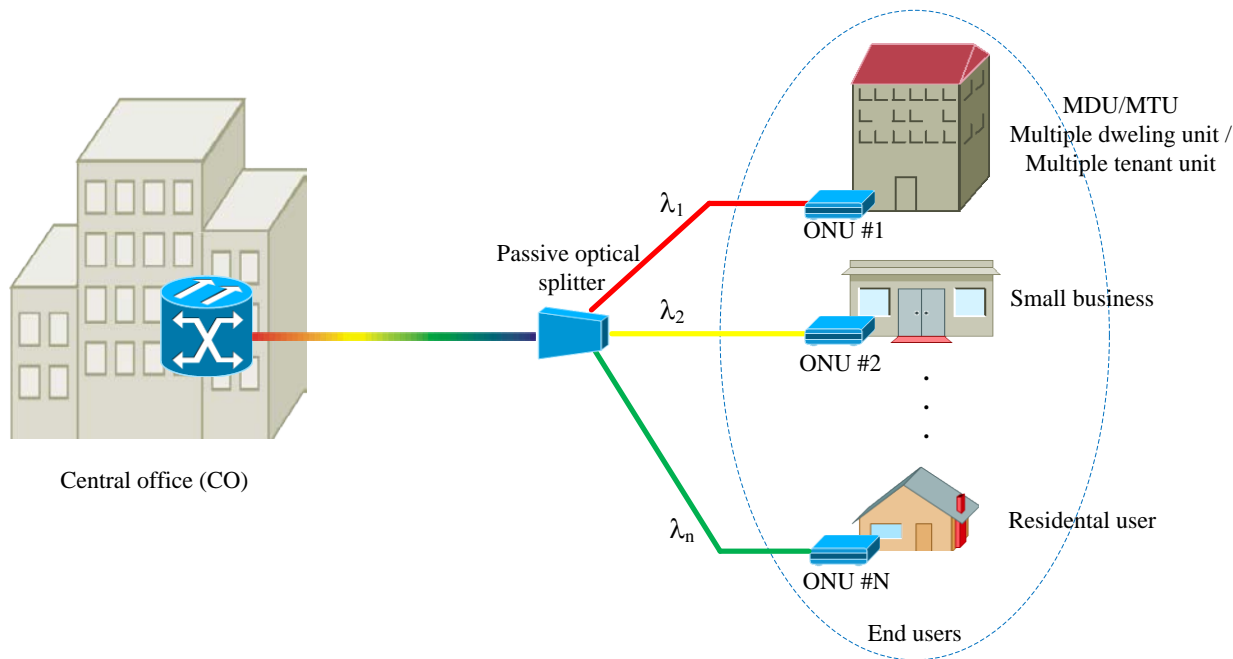

Currently, there is no common standard for WDM PON, but the development of these networks is considered to be the key factor for the further development of access networks.

# Single-channel EPON (Ethernet PON)

---

The Emerging WDM EPON

# Single-channel EPON

- In last decade, TDM-based Ethernet passive optical networks (EPONs) were considered as a potential optimized architecture for the access network.
- EPONs are designed to carry Ethernet frames at standard Ethernet rates where architecture is passive with only active the end terminating equipment.

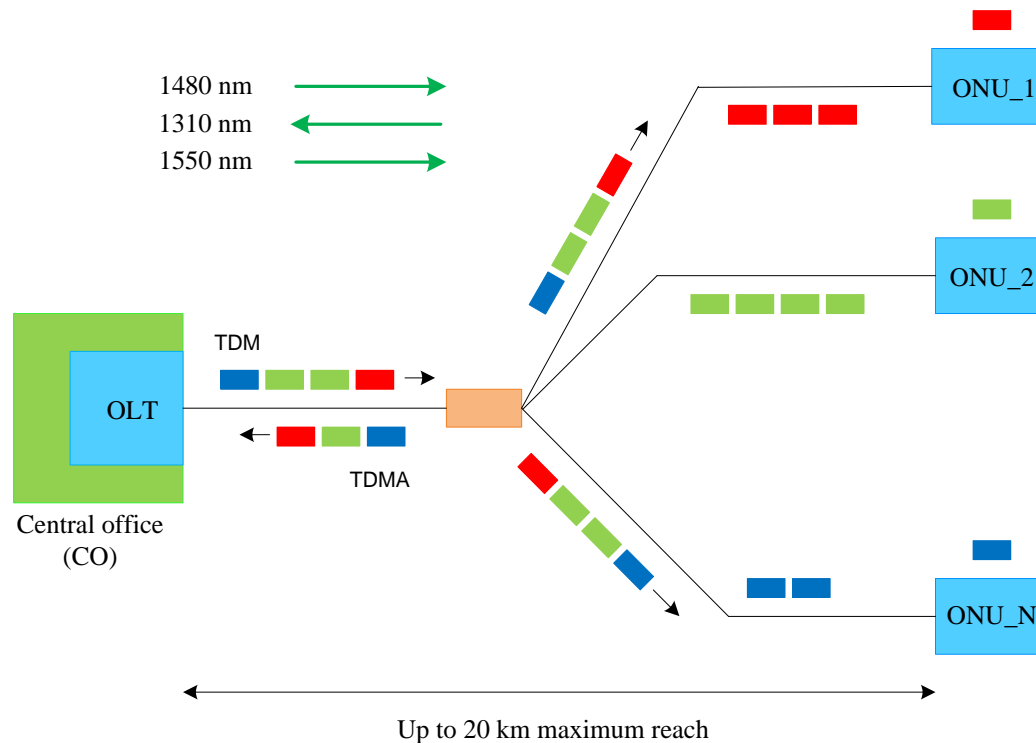



# Single-channel EPON transmission

- In the downstream direction, Ethernet packets are transmitted by the OLT and they pass through a passive splitter or cascade of splitters and reach each ONU.
- The splitting ratio is limited by the available optical power budget and it typically ranges from 4 to 64.
- In this direction, EPON acts as a shared medium network where its operation coincides with the operation of a conventional 'broadcasting' Ethernet network.
- Packets are broadcast by the OLT and selectively received by each station based on the destination MAC address from the Ethernet header.

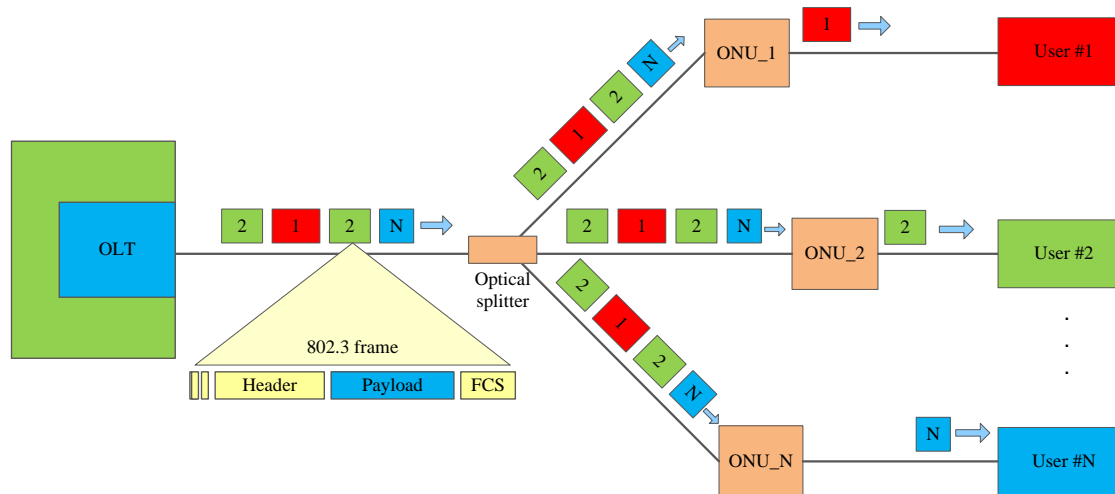

# Single-channel EPON transmission

- In the upstream direction, the EPON architecture is thought of as the classical point-to-point architecture where multiple ONUs transmit data packets to the OLT through the common passive combiner and share the same optical fiber from the combiner to the OLT.
- The IEEE 802.3ah task force has standardized only the control and management messages used to control the data exchange between the OLT and the ONUs as well as the processing of these messages through the development of the MPCP (Multipoint Control Protocol).
- MPCP is just a supporting control mechanism that facilitates the implementation of various bandwidth allocation schemes in EPON.

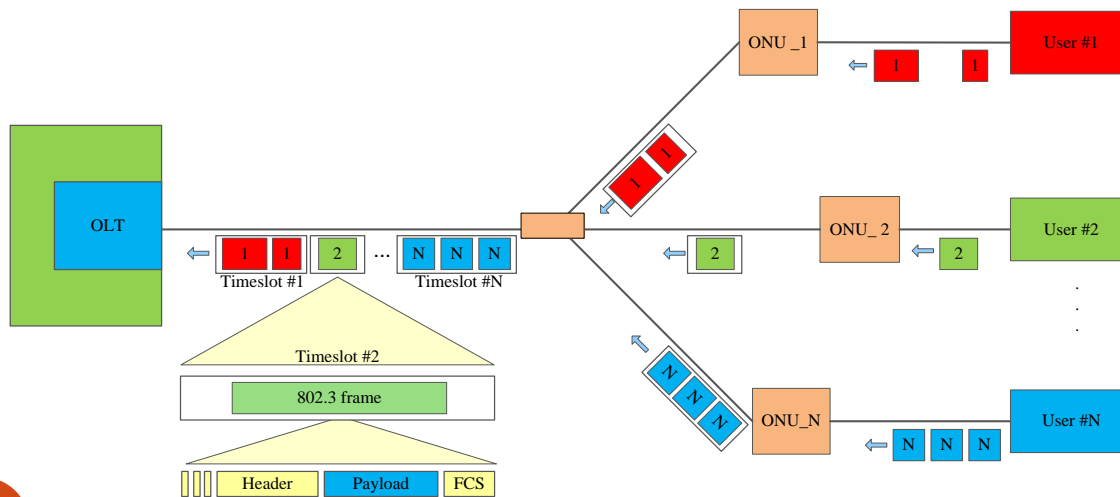

The DBA (Dynamic Bandwidth Allocation) implementation is left to the equipment vendors, where the device interoperability is ensured by the standardization of the MPCP.

# QoS support

- **EF (Expedited Forwarding) traffic class** – highest priority traffic class for delay-sensitive traffic with constant bit rate. This class is intended for services such as voice and other delay-sensitive applications that require bounded end-to-end delay and jitter specifications;
- **AF (Assured Forwarding) traffic class** – medium priority traffic for not delay-sensitive traffic with variable bit rate. AF class is intended for services such as video transmission that are not delay-sensitive but which require bandwidth guarantees;
- **BE (Best-Effort) traffic class** – low priority traffic class for delay-tolerable services that include web browsing, file transfer and e-mail applications. Also, applications that belong to this traffic class do not require any guarantees in terms of jitter and bandwidth.

# QoS support

- In addition to the DiffServ support, two independent additional mechanisms should be implemented:
  - Inter-ONU: scheduling at the OLT (inter-ONU scheduling or dynamic bandwidth allocation (DBA));
  - Intra-ONU: scheduling at the ONU for scheduling packets that belong to different traffic classes.

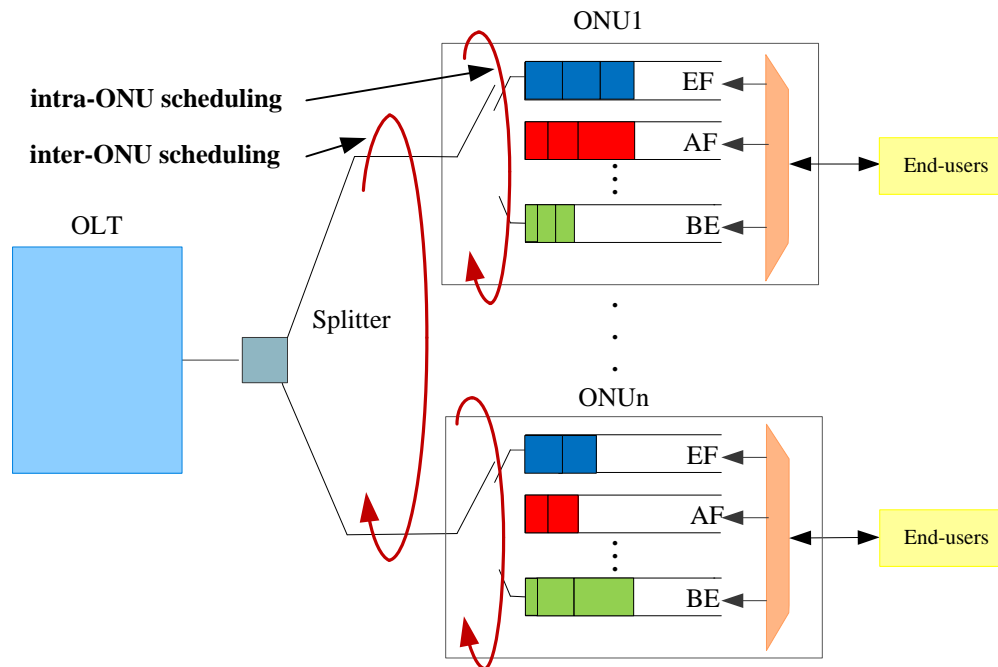

# Efficient DBA model for single-channel EPON with QoS support

- The authors presented Hybrid granting protocol with priority based scheduling (HG(PBS)) model that separates the transmission of high priority traffic from the transmission of lower-priority traffic, and introduces the implementation of Intra-ONU scheduling algorithms for the transmission of lower traffic class;
- Hence, the HG protocol defines two subcycles for data transmission, one for the EF traffic, with the use of a GBR (GRANT before REPORT) mechanism, and one for the AF/BE traffic, with the use of a GAR (GRANT after REPORT) mechanism.

# HG(PBS) model

- The HG scheduler ensures that higher-priority traffic is served with less average delay and jitter and does not allow the EF traffic to occupy the entire bandwidth.
- Intra-ONU scheduler at each ONU guarantees minimal bandwidth allocation to each service class with different priorities for each user.
- It can also guarantee the minimal bandwidth allocation to each traffic queue.
- The analyzed solution can fulfill the QoS requirements in EPON and improve the transmission efficiency of multimedia traffic.

# Multichannel EPON

---

The Emerging WDM EPON

# Single-channel EPON drawbacks

- The development of new applications and services, has caused the increase in the need for higher bandwidth and higher speeds in the access network and these cannot be fully realized with the conventional single-channel EPON network.
- Each subscriber transmits over the same fiber, but the time during which they are allowed to 'occupy' the fiber is allocated by the OLT at the central office through the implementation of various bandwidth allocation algorithms.
- This concept, where many users share a common fiber, helps minimize the fiber infrastructure but at the same time, it presents the main limitation for the realization of the high-speed access network.
- QoS support requires additional mathematical models – rapidly raises the prices of components and overall systems

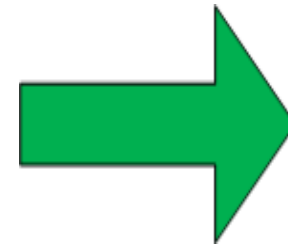

**WDM EPON**



# WDM EPON

- Some advantages of the WDM EPONs include:
  - Dedicated bandwidth, guaranteed QoS;
  - Physical P2MP, logical P2P;
  - Protocol and data-rate transparency;
  - Simple fault localization;
  - Better security;
  - Possibility for service differentiation.

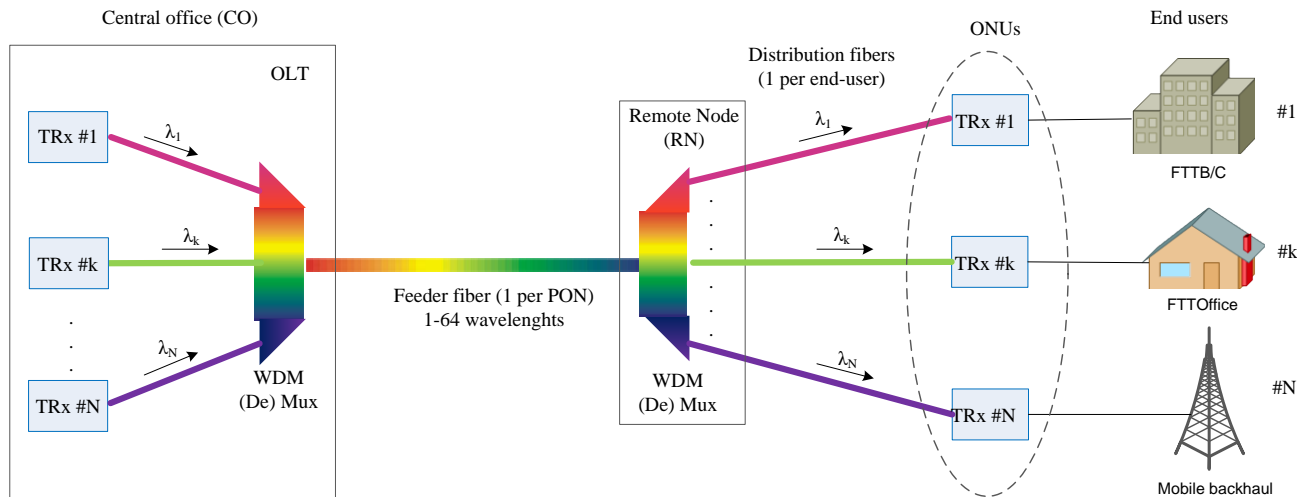

# WDM EPON

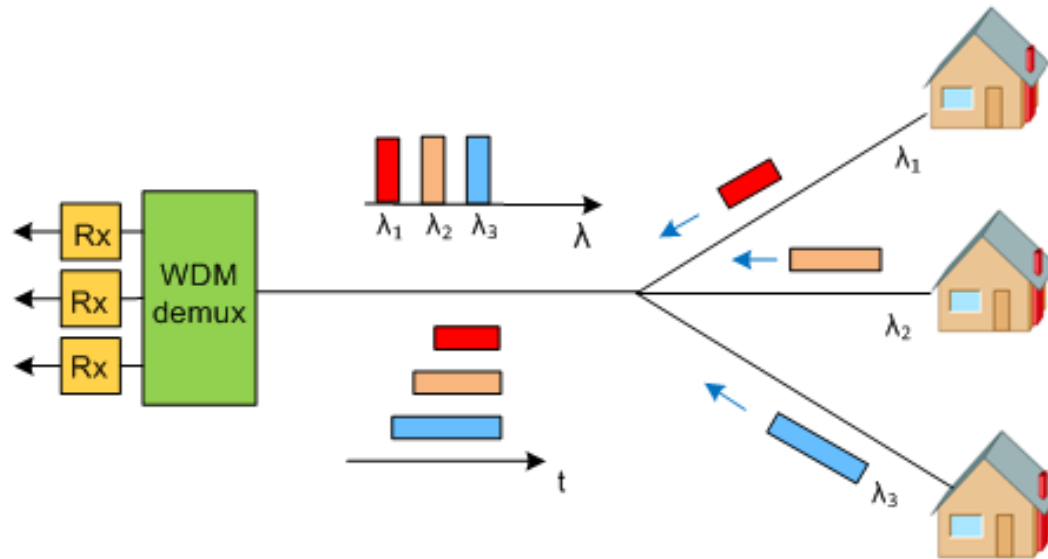

- Points that must be considered:
  - Multidimensional scheduling: bandwidth allocation (*grant sizing*) and wavelength allocation (*grant scheduling*);
  - TDM → WDM system migration;
  - MPCP extension – information about supported wavelengths;
  - Optical transmitters/receivers in OLT and ONUs.

# WDM EPON resource allocation

- **Upstream bandwidth allocation**

- *Offline* mechanism;
- *Online* mechanism.

- **Wavelength allocation**

- Separate time and wavelength assignment;
- Joint time and wavelength allocation.

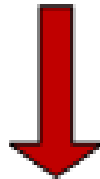

***DWBA -Dynamic Wavelength and Bandwidth Allocation***

# Hybrid TDM/WDM EPON - suggested solution

- Hybrid TDM/WDM EPON network
- DWBA models:
  - **Bandwidth allocation (*grant sizing*)**
    - ✓ Proposed new mathematical model based on new model called MG-IPACT (*Modified Gated IPCAT*);
  - **Wavelength allocation (*grant scheduling*)**
    - ✓ New approach in wavelength allocation;
  - **Nonsupport**
    - ✓ **A novel approach in analyzing QoS in WDM EPON in which wavelength assignment takes place per service class and not per ONU;**
  - **MPCP extensions**
    - ✓ The MPCP GATE message is modified by means of an additional field (one byte) indicating the channel number assigned by the OLT to the ONU.

# Hybrid TDM/WDM EPON - DWBA models

- **FWPBA (*Fixed Wavelength Priority Bandwidth Allocation*) model**
- **DWPBA (*Dynamic Wavelength Priority Bandwidth Allocation*) model**
- Both models incorporate a novel approach in analyzing QoS in WDM EPON in which wavelength assignment takes place per service class and not per ONU, as it has been a common approach in literature so far.
- There is not necessary the implementation of additional complex algorithms for QoS support, which in turn significantly reduces DBA complexity and directly decreases system cost in comparison with various QoS DBA models which have been published until now.

# System architecture

- Four wavelengths:  $\lambda_0$ ,  $\lambda_1$ ,  $\lambda_2$  and  $\lambda_3$ ;
- $\lambda_1$ ,  $\lambda_2$ ,  $\lambda_3$  - reserved for the data transmission;
- $\lambda_0$  - reserved for the synchronization and transmission of control protocol messages.

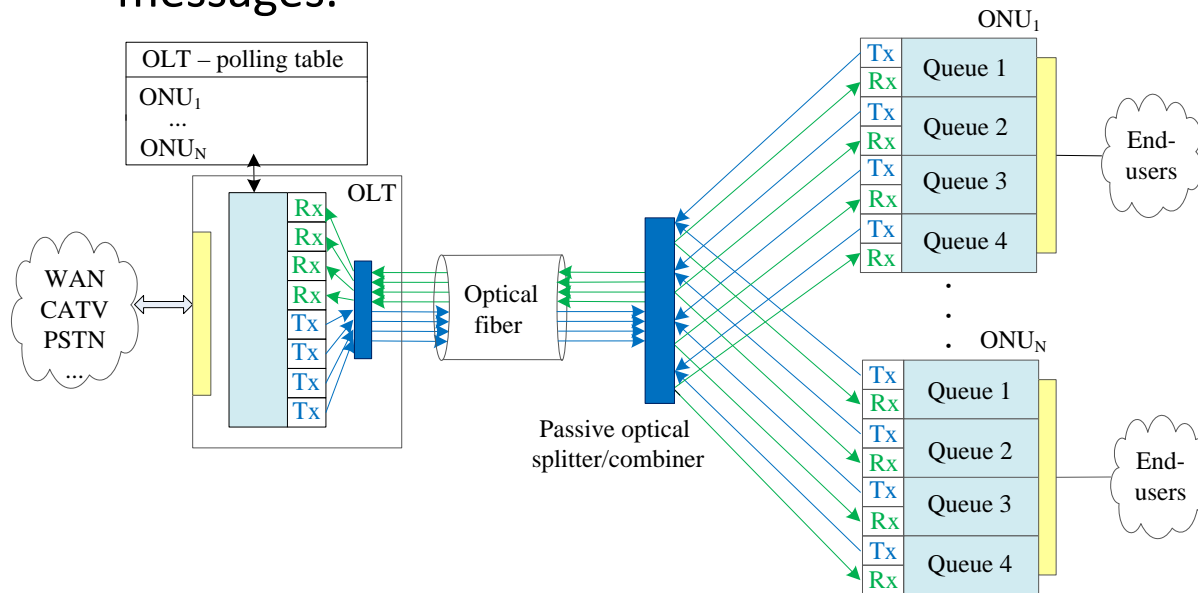

Headend: four fixed transmitters for simultaneous downstream transmissions, and four fixed receivers that are constantly receiving data transmitted by ONUs in all upstream channels

Fixed-tuned transceivers in the OLT and ONUs, one for each operating wavelength channel in order to enable simultaneous transmission of traffic in one station on different wavelengths (tuned on cost effective C-band wavelength).

# QoS support

- The QoS support is implemented in accordance with the DiffServ model:
  - **EF (Expedited Forwarding)** - highest priority traffic class for delay-sensitive traffic with constant bit rate;
  - **AF (Assured Forwarding)** – medium-priority traffic for not delay-sensitive traffic with variable bit rate;
  - **BE (Best-Effort)** – low-priority traffic class for delay-tolerable services that do not require any guarantee.

# DWBA implementation

- In both models, the transmission of different traffic classes is segregated by wavelengths in the following way:
  - $\lambda_1$  wavelength is allocated for transmission of highest priority EF traffic class;
  - $\lambda_2$  wavelength is allocated for transmission of medium-priority AF traffic class;
  - $\lambda_3$  wavelength is allocated for transmission of lowest priority BE traffic class.
- Having segregated the transmission of traffic classes, there is no need for the implementation of an additional algorithm for QoS support.
- The presented models are completely in compliance with the IEEE 802.3ah standard and incorporate the previously mentioned offline scheduling in order to support the QoS implementation.



# The FWPBA model

- Each data wavelength is strictly associated with a single traffic class and can only be used for the transmission of such traffic class - an ONU retains all three wavelengths until the transmission on all three wavelengths is finished; does not use system resources efficiently.

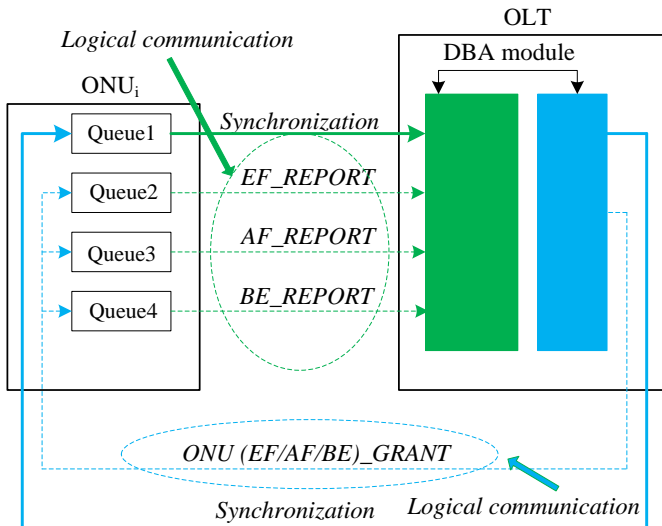

- One wavelength transmits only one defined traffic class.
- When the upstream transmission of all traffic classes is finished, ONU releases wavelengths and the next scheduled station can transmit the traffic.
- Therefore, the most loaded wavelength dictates the duration of the transmission within the observed unit.
- Consequently, wavelengths that occupy minor bandwidth have to wait until the transmission on the most loaded wavelength is over.
- This introduces new waiting time.

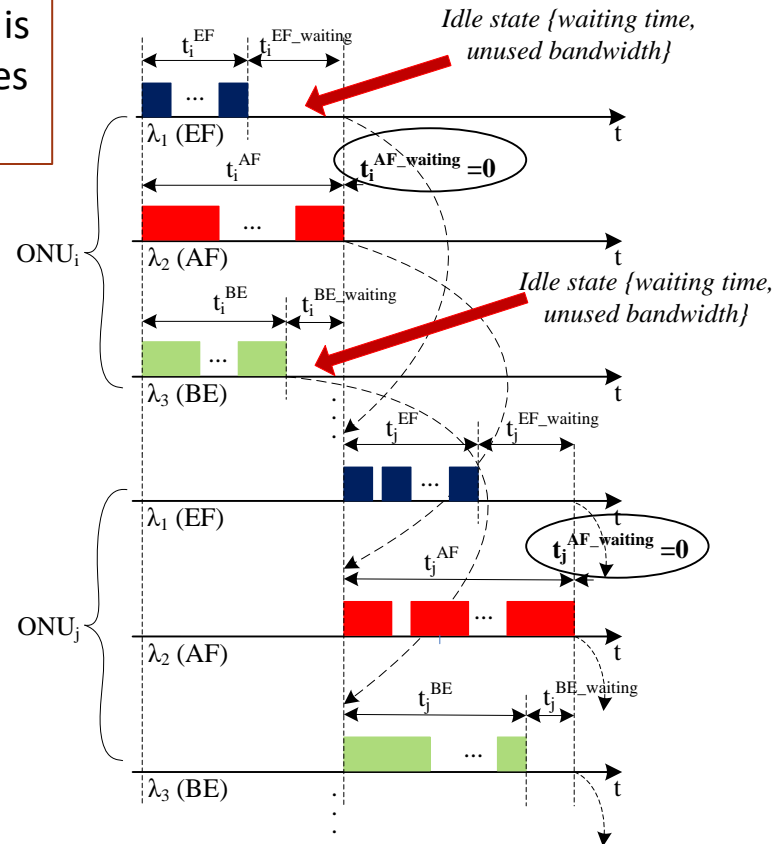

OLT – polling table

λ <sub>1</sub> (EF)	ONU <sub>i</sub> ⇔ ONU <sub>j</sub>
λ <sub>2</sub> (AF)	ONU <sub>i</sub> ⇔ ONU <sub>j</sub>
λ <sub>3</sub> (BE)	ONU <sub>i</sub> ⇔ ONU <sub>j</sub>
	⋮
	⋮

# The DWPBA model

- In the DWPBA model, the wavelength on which an ONU has finished transmission of the defined traffic class is immediately released and allocated to the next ONU for the transmission of the same class in accordance with the OLT polling table.
- One wavelength could be used only for the transmission of the defined traffic class, just as it was the case in the FWPBA model.

- When the transmission on one wavelength in the selected ONU is over, that wavelength is scheduled to the next ONU for the transmission of the same (defined) traffic class.
- The allocation of wavelengths is completely asynchronous, and at one point assigned to different wavelengths of ONUs.

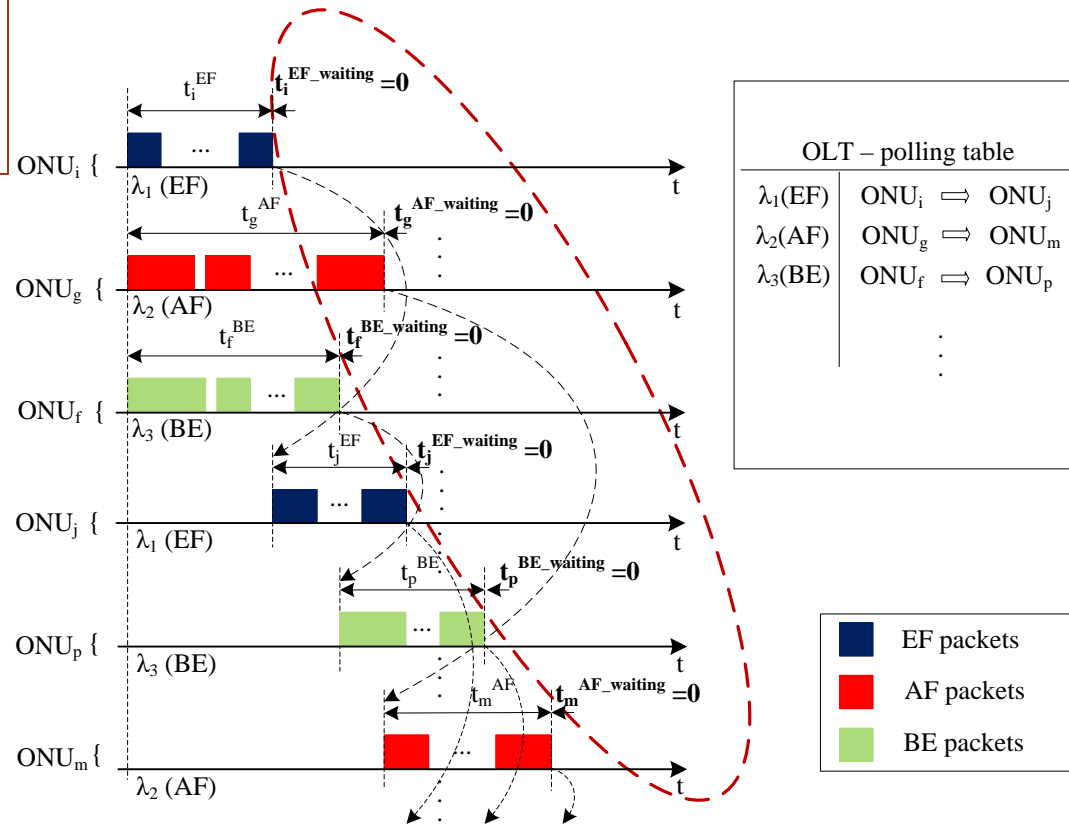
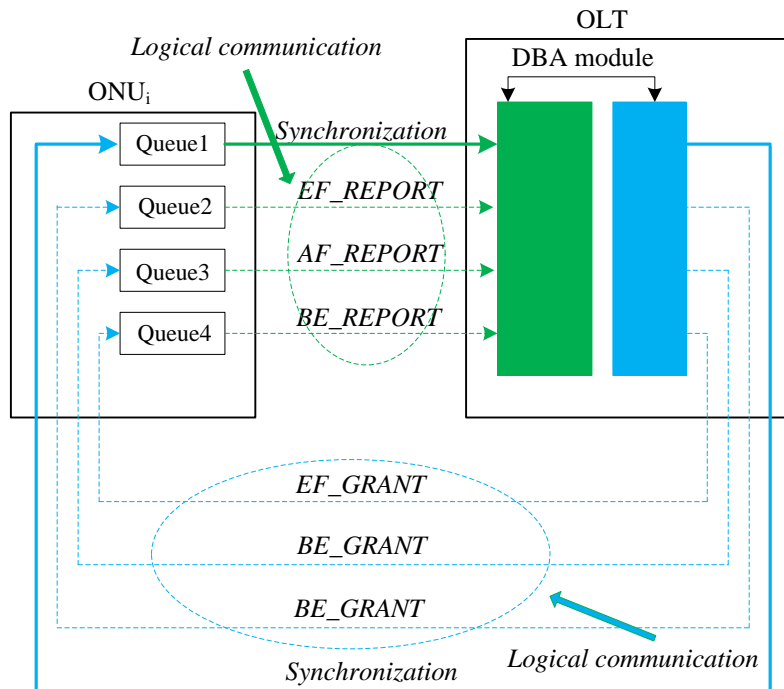

Different traffic classes are no longer synchronized and allocated to one station simultaneously.

# Further model development

- The enhanced dynamic wavelength priority bandwidth allocation with fine scheduling (DWPBA-FS) model includes a hybrid inter/intra-ONU scheduling mechanism where both the OLT and ONUs are responsible for performing packet scheduling.
- The model includes an extension of the MPCP, thus allowing the presented architecture and model the possibility of an incremental upgrade from TDM EPON to TDM/WDM EPON per need basis.
- As opposed to the FWPBA and DWPBA models, where the control wavelength is used exclusively for the synchronization and exchange of control messages, in the DWPBA-FS model this control wavelength is now used for data transmission.
- The exchange of control messages in the enhanced model now takes place on data wavelengths, where the processing is carried out in accordance with the MPCP protocol.

# The DWPBA-FS model

- The DWPBA-FS model further develops the DWPBA model with the introduction of new traffic subclasses in the system in accordance with the Diffserv model:
  - EF (Expedited Forwarding) - highest priority traffic class;
  - AF (Assured Forwarding) - medium-priority traffic class that is further divided into four subclasses according to the standard (traffic is listed by priority, from highest to the lowest):
    - ✓ AF4 (e-commerce applications);
    - ✓ AF3 (mission critical application);
    - ✓ AF2 (non-organization streaming audio and video), and
    - ✓ AF1 (bulk traffic);
  - The first two AF subclasses could be defined as premium and normal business applications, and another two as premium and home business applications. If the congestion occurs between classes, the traffic in the higher subclass gets priority over the lower traffic subclasses;
  - BE (Best-Effort) – low-priority traffic class.
- With the aim of reserving bandwidth for the four AF subclasses, authors propose the implementation of the WFQ (Weighted Fair Queuing) as a scheduling algorithm in ONUs since this method is able to automatically smooth out the flow of data by sorting packets which ultimately minimizes the average latency and improves system performances.

# The DWPBA-FS model

- For the transmission and segregation of different traffic classes by wavelengths the following scheme is implemented:
  - $\lambda_1$  is allocated for the transmission of EF traffic class;
  - $\lambda_2$  and  $\lambda_3$  are allocated for the transmission of the AF traffic class, i.e. AF1, AF2, AF3 and AF4 traffic subclasses;
  - $\lambda_4$  is allocated for the transmission of BE traffic class.

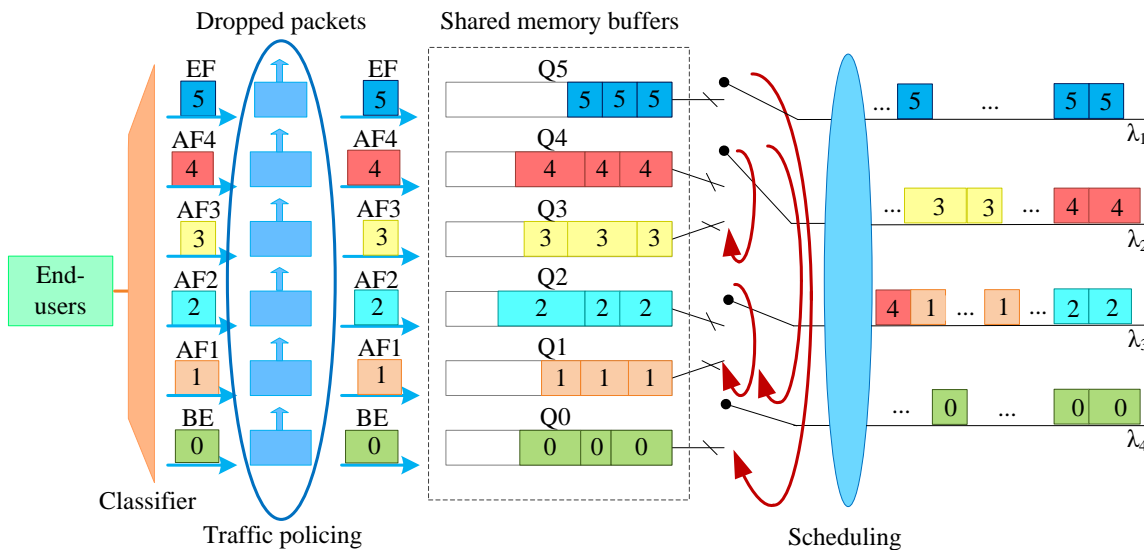

Two wavelengths in one ONU are simultaneously use for AF class since most applications and services are multimedia-based and in years to come, the different forms of video applications will account for approximately 90% of consumer traffic

# Conclusion

---

The Emerging WDM EPON

# Conclusion

- Since the next wave in the development of next generation networks has already begun, service providers are investing in the development of new solutions in order to foster communications, expand the service portfolio and create a greater value through various services and multimedia-based applications.

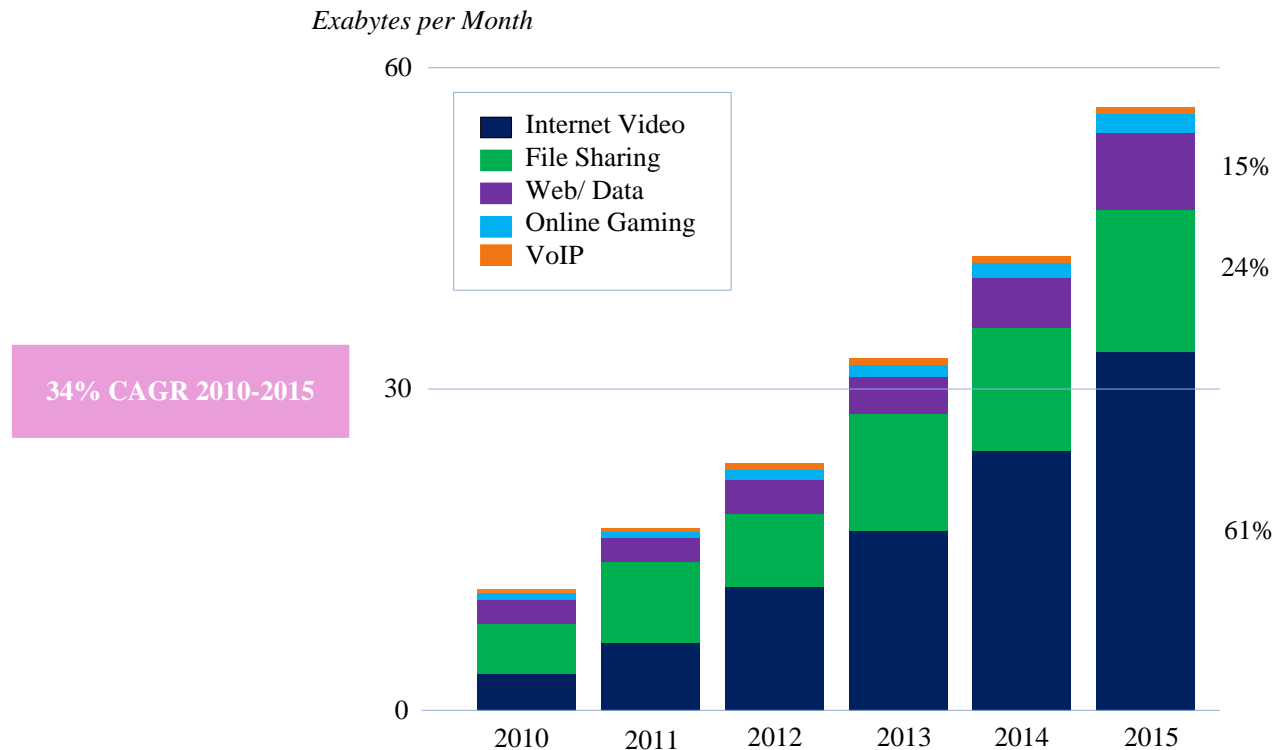

# Conclusion

## Next generation networks

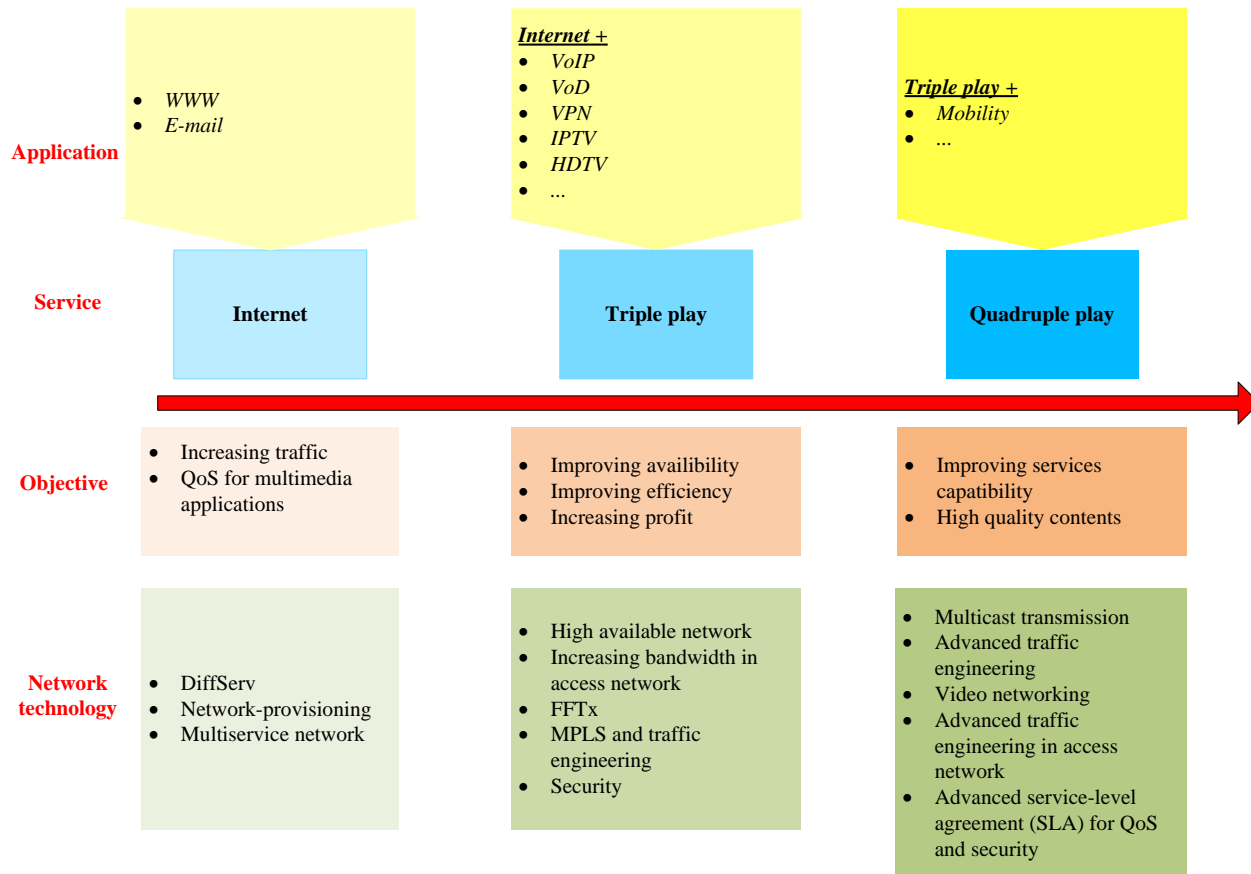

Various new applications demand the increase in the bandwidth available in the access networks along with the ultimately improved QoS parameters. It means that the further development of the access networks must be encouraged for the sake of the further development of the NGN networks and Internet itself.



# Conclusion

- Simulation results confirm the superiority of the DWPBA-FS model and with the introduction of new subclasses.
- WDM EPONs are capable to efficiently manage different video-based applications that will most likely be prevalent in future networks.
- Authors believe that the DWPBA-FS model may become an eligible candidate for wavelength and bandwidth allocation in next generation EPON networks.
- Moreover, since the network model incorporates all key parameters of multimedia ISP network, we are convinced that the implementation of a hardware for the solution we here propose would enable network operation in a manner which could be easily foreseen and would therefore not involve any complexities related to the implementation of additional algorithms which are commonly found within other solutions which have been proposed so far.